

## Important Note



For best results, use VidaMount VESA brackets (from VidaBox) for this enclosure. It has been specifically fitted to work with this item.

Other VESA mounting hardware can only be used after carefully checking the VESA mount screw length (Step F). Too long a screw will crush and damage the iPad!

## F Check VESA screw length (On non-VidaBox VESA Mounts)

With the VESA screws installed, look on the inside of the back plate.

Check to make sure that the screw lengths DO NOT PROTRUDE beyond 1/16" from the back plate surface. See diagrams below.

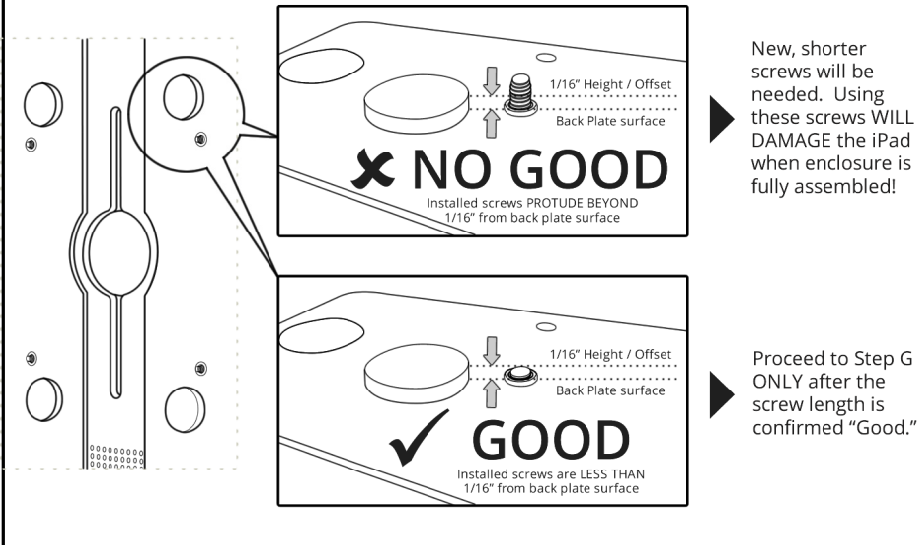

## G Reassemble the Enclosure

Reinstall the (8) screws removed in Step A.

Be sure the iPad cable can be routed out of the enclosure. If not, go back to Step C and cut the grooves needed.

iPad USB-C Cable

The iPad is now securely installed in the enclosure!

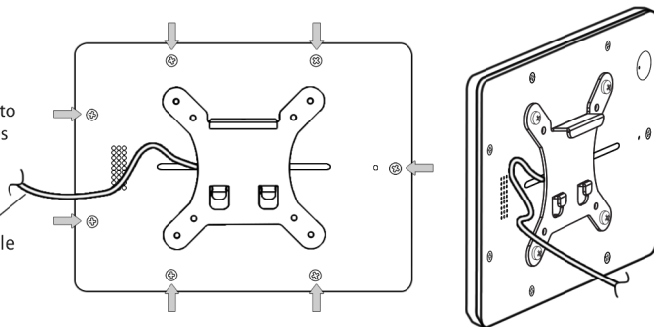

# INSTALLATION GUIDE

## VidaMount VESA Tablet Enclosure For iPad Pro 11-inch Tablets

### VB\_VESA\_IPRO110

Designed to securely enclose iPad Pro 11-inch tablets

Fits iPad Pro 11-inch tablets ONLY

Compatible with VESA 100x100 mounts

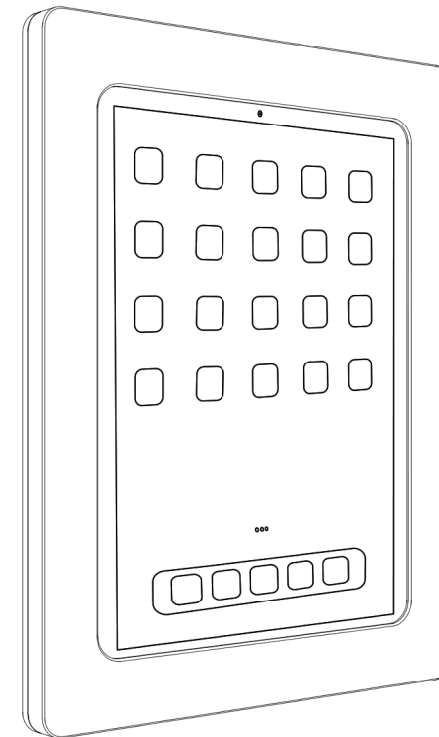

(iPad is shown for illustrative purposes & not included)

# Installation Instructions

## VidaMount VESA Tablet Enclosure - iPad Pro 11"

### Important Note



For best results, use VidaMount VESA brackets (from VidaBox) for this enclosure. It has been specifically fitted to work with this item.

Other VESA mounting hardware can only be used after carefully checking the VESA mount screw length (Step F). Too long a screw will crush and damage the iPad!

### Component Checklist

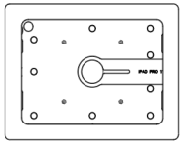

iPad Resin Enclosure  
(Already assembled)

#### TOOLS YOU'LL NEED (not included)



Phillips head  
Screwdriver

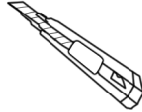

Knife / Box Cutter  
(OPTIONAL)

### A Disassembling the Enclosure

Remove the flat-head screws as shown. Set aside the loose hardware carefully.

We will need this hardware again later.

We now have (2) pieces:  
A. The front face plate  
B. The back plate

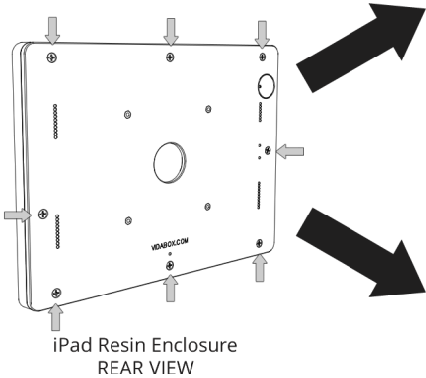

iPad Resin Enclosure  
REAR VIEW

#### A. FRONT FACE PLATE

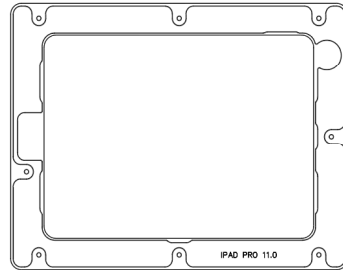

B. BACK PLATE

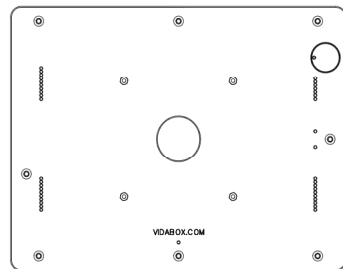

**IMPORTANT:** Diagrams are generalized for iPads - your exact enclosure may appear slightly different!

### B Optional : Remove Power Button Knockout (If needed)

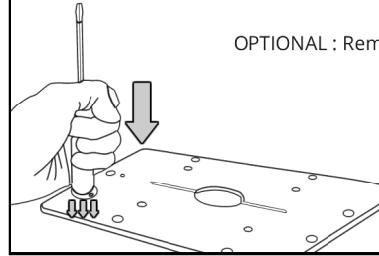

OPTIONAL : Remove only if access to the power button is always required.

Using the blunt end of the screwdriver, press down on the circular knockout, as shown.

This will pop out the power button access panel.

### C Optional : Cut Wiring Grooves (If needed)

OPTIONAL : Remove only if necessary.

If using a VESA mount where the center wiring hole is blocked, use a knife / box cutter, and cut out the grooves.

This will allow the tablet's wires to be routed properly.

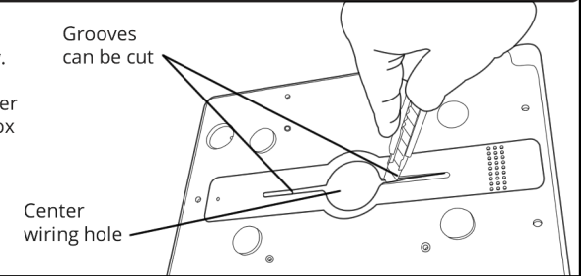

### D Install iPad into Front Face Plate

Orient the iPad properly and install it into the front face plate as shown.

Be sure that the power button, volume buttons, and USB-C cable ports line up properly.

Connect the iPad cable now. It will need to be routed through the center hole in the next steps.

iPad Cable

USB-C  
Cable  
Port

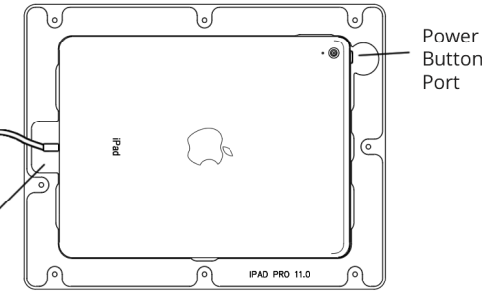

### E Install VESA Mount onto Back Plate

Install the VESA mount we'll be using onto the back plate.

